



Doorsets for mental health environments

Kingsway are the specialist manufacturer of pre-hung doorsets for the secure healthcare sector; supplying complete, fully-fitted doorsets for the most demanding healthcare environments. As a member of the third party Q-Mark fire door certification scheme, we provide the expertise to guarantee the successful outcome of your project and ensure compliance with regulations.

Installer Qualifications

Doorsets are technical products and should only be installed by competent personnel with suitable experience.

If full certification is needed, doors should be installed by BM Trada Q-Mark Scheme certified Fire Door Installers or by Kingsway Installers. It is the responsibility of the Client or Principal Contractor to ensure that only competent and correctly qualified persons are used for the installation process, as a poor installation will result in a lack of compliance and performance. Kingsway cannot sign off installation works by other contractors.



Storage, Protection & Handling



Pre Delivery Planning

Depending on the size of the delivery, the doors will be delivered by van or lorry and will arrive wrapped and multi-packed onto pallets. Please ensure a forklift or telehandler is available for pallet moving. Alternatively, if moving by hand, we suggest you provide 4 persons for the off load. By prior arrangement, a moffett enabled delivery may be possible at additional cost. Delivery scheduling and cost will be advised on estimate and we reserve the right to charge for failed or additional deliveries. We ask for 48hrs notice to postpone any scheduled deliveries.

Storage

It is essential that Kingsway doorsets are stored correctly to ensure that they appear and perform as specified. It is the responsibility of the contractor to ensure that all doorsets delivered are stored in a suitable area where they will be protected from harm by the elements and physical damage. The guidance below should be followed without exception:

- Doorsets should be stored near to the installation location, in a dry, well-ventilated area which has low moisture levels.
- Doorsets should always be stored horizontally to a maximum of 6 per stack. Cardboard bearers or equivalent should be used between each doorset to ensure hardware does not touch. Bearers should line up with each other down the stack to stop doorsets becoming bowed or twisted.
- Protective packing is there to ensure the doorset is installed without damage, do not unpack doorsets unless they are due to be installed. If a doorset has been unpacked prematurely it should be repacked and stored safely until ready for installation.

Protection

After installation, it is essential to protect the doorsets until handover of the building as other trades will be continuing around them. Suitable protection should be given to the doorsets against paint, dirt, minor impact and general use.

It is the overall responsibility of the contractor to assess how much protection is required and to provide it where necessary. Consideration should be given if doors are in direct sun light, as anything placed across the doorset may cause a silhouette marking to be left.

Handling

Kingsway doorsets are a high quality product that should be cared for accordingly. Our products are late second fix items and should only be installed after all wet trades have finished on site and the moisture level has returned to within the standard levels.

Extra care should be taken in the physical handling of Kingsway doorsets as these can often include heavy glazed panels or additional trims and fittings which contribute to the weight of the doorset. When lifting a doorset, make sure that there are enough personnel to assist and always work in accordance with the site's manual handling policy.



Relative Humidity Rating (%)	Effects
Below 40%	Materials are susceptible to 'case hardening' where the cell structure is at risk of deformation (bowing/warping). Control measures are required.
40-60%	Optimum level. Acceptable levels of moisture.
60-75%	Materials begin to absorb moisture resulting in expansion and de-stabilisation. Control measures are required.
Above 75%	Materials absorbing high levels of moisture resulting in excessive swelling that may not be rectified. Activity must stop.

Pre Install Planning for Approved Installers

Our doorsets arrive as single pre-hung units, complete with frames, architraves and all components factory fitted. We recommend they are installed after second fix carpentry phase to avoid the risk of damage. We also recommend they are installed after room furniture if possible. Flooring should be installed and finished ahead of door installation so that the door leaves do not need to be removed from their frames.

Check that you have the correct doorset for the opening and that it is free from any signs of damage. All doorsets are clearly labelled for correct identification, both on the outer packaging and also on the frame legs. Do not install a doorset into an opening that it has not been manufactured for and do not alter the size of a doorset to fit as this will invalidate the fire rating.

Before removing the packaging, check that the opening is big enough and that it is square. Any changes to the opening should be made at this point, prior to fully unpacking. Optimum gaps around the doorset are 7mm on each frame leg and 10mm on the head.

Check the floor levels. As many of Kingsway's doors are double action, the door will swing both inwards and outwards, meaning the level of the floor is critical. The floor level can cause the door to bind if the door catches on it, or it can make void the fire certification if the floor drops away at the threshold leaving a gap bigger than 8mm when the door is in closed position.

Check that you have suitable fixings for the wall that you are fixing into, and take care to note where wires are present when you plan your fixing points. Details on fixing requirements are shown on page 5.



How to identify which door I have?

Q-Mark Fire Door Plugging Details

The Q-Mark scheme uses plugs to identify the status and fire integrity of the doorset.

- Blue outer plug means the doorset has 60 minutes fire integrity (FD60).
- Yellow outer plug means the doorset has 30 minutes fire integrity (FD30).
- Red inner core means the door leaf is Q-Mark approved.
- Orange inner core means the glazing fitted to the door is Q-Mark approved.
- Silver inner core means that it is a complete, factory hung doorset.

Plugging of fire rated timber doorsets must be in the head of the door. This is located centrally across the width and 50mm from the opening edge of the door to allow the plugs to be seen when the doorset is installed. Where it is not possible to fit plugs in the head of the door, they should be fitted 50mm up from the bottom of the leading edge or on the door stop. Where glazing has been installed in the door leaf, the orange core plug should also be installed 30mm on from the doorset plug to indicate that the glazing installed is certified and has been factory fitted.



All Q-Mark certified doorsets must be installed without making changes to the configuration of hardware. No allowance is made for any extra fittings or vision panels to be added to them as they have been supplied as a certified complete doorset.



Example: An FD30 door having a vision panel will have 3 yellow plugs fitted: 1 with red inner core to show the door leaf is Q-Mark approved for 30 minutes fire integrity; 1 with orange inner core to show that the vision panel is Q-Mark approved for 30 minutes fire integrity; and 1 with silver core to show that the whole doorset has been factory hung and is Q-Mark approved for 30 minutes fire integrity.

Frame Fixing & Packing

When installing fire rated doorsets the correct choice of packers, fixings and sealants is critical to the performance of the door, both in terms of everyday use and in its fire performance. Care should be taken to follow the guidance below:

Install gaps

- Ensure suitable packers are used when positioning the door. These include timber shims and intumescent packers. For FD60 doorsets hardwood shims should be used. Care should be taken to ensure the packers are a tight fit yet do not bow the frame. The gap between the leaf and the frame should be kept within the tolerance of 2-4mm that it was supplied as and from the door to the threshold of 7-8mm to ensure fire and smoke integrity and validity of certification.

Fixings

- Fixings used should be suitable to the construction of the opening (see diagram) and should be positioned 100mm in from the top and bottom of each frame leg and also positioned between 400mm and 500mm apart. For the hanging jamb, pairs

Diagram 1

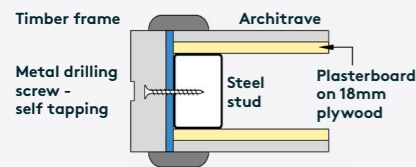

Diagram 2

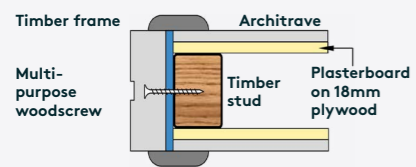
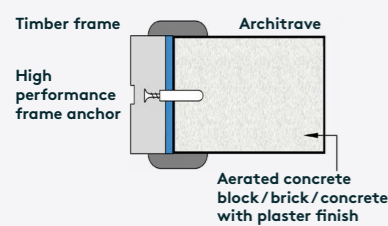

Diagram 3



Intumescent mastic

Kingsway recommend using intumescent packers and proprietary fire stopping (expanding PU foam) product for gaps of up to 20mm. Products must be tested for this application to BS 476: part 22: 1987 or BS EN 1634-1: 2000 or 2008.

of fixings should be used (see individual doorset drawings) and for the closing leg of the frame pairs of fixings should be used if the thickness is over 150mm. Where the frame is over 900mm wide, a fixing should be used in the frame head to ensure a correct gap is maintained with the door. Fixings should not be any nearer than 35mm from the wall face to avoid breaking out the wall surface.

- Test door action 90° both ways while fixing.
- The size of the fixing used can be determined by using the chart on the right. As a rough guide, fixings need to have a minimum of 60mm anchorage into the wall construction (85mm for heavy doorsets) taking into account any packing material used.
- For steel stud wall constructions as typical in contemporary new build scenarios, we recommend that door openings include timber (hardwood or softwood) inserts/ grounds behind the steel stud to reinforce door fixing and enhance the rigidity of the structural opening. Timber grounds must extend to the full height of the partition around door frames and should be of sufficient cross sectional dimension to provide 40mm to 60mm screw penetration. Upon request, we can provide a schedule of door weights to assist design of wall structures.
- Traditionally, once secured, the frame should be packed with rock fibre and capped on the front face with intumescent

mastic, however, contemporary installation methods would use expanding foam e.g. Blue 60 + Blue 60 packers in place of rock fibre, as long as the manufacturer has the data to cover the product for this type of application. BS EN 1634-1 & BS 476 part 22.

Architraves

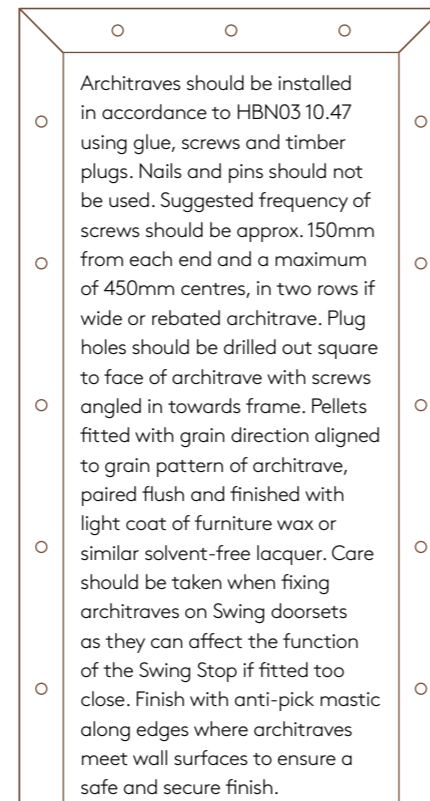

Fixing Selector					
Wall material					
Frame Thickness	Steel Stud	Timber Stud	Aerated Concrete Block	Brick	Concrete
32mm	Drill Tec 5.5 x 85 Metal Drilling Screw	5 X 100mm Sonic Multi-purpose Woodscrew	SXRL 100mm High Performance Frame Anchor	SXRL 100mm High Performance Frame Anchor	SXRL 100mm High Performance Frame Anchor
44mm	Drill Tec 5.5 x 100 Metal Drilling Screw	5 X 120mm Sonic Multi-purpose Woodscrew	SXRL 120mm High Performance Frame Anchor	SXRL 120mm High Performance Frame Anchor	SXRL 120mm High Performance Frame Anchor
60mm	Drill Tec 5.5 x 120 Metal Drilling Screw	6 X 150mm Sonic Multi-purpose Woodscrew	SXRL 160mm High Performance Frame Anchor	SXRL 160mm High Performance Frame Anchor	SXRL 160mm High Performance Frame Anchor
Fixing Performance					
Fixing type	Individual Fixing Performance	Number Required Per Frame Leg	Overall Performance Of 1 Frame Leg		
Drill Tec 5.5-gauge Metal Drilling Screw in Steel Stud	12.5Kn	4	50Kn		
5 X 100mm Sonic Multi-purpose Woodscrew In Timber Frame	0.3Kn	5	1.5Kn		
SXRL 100mm High Performance Frame Anchor in Aerated Block	0.32Kn	5	1.6Kn		

Calculation of Force: A person weighing 100kg running at 7m/s will exert <1Kn

DOORSET INSTALLATION

SWITCH

SWITCH is the world's first and only hinge-side anti-barricade door system, designed for fast, controlled, and safe overcoming of barricading incidents by keeping staff in the 'Green Zone'.

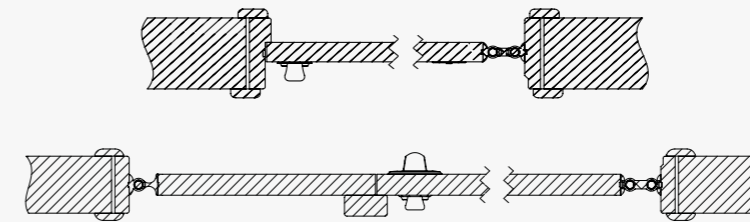
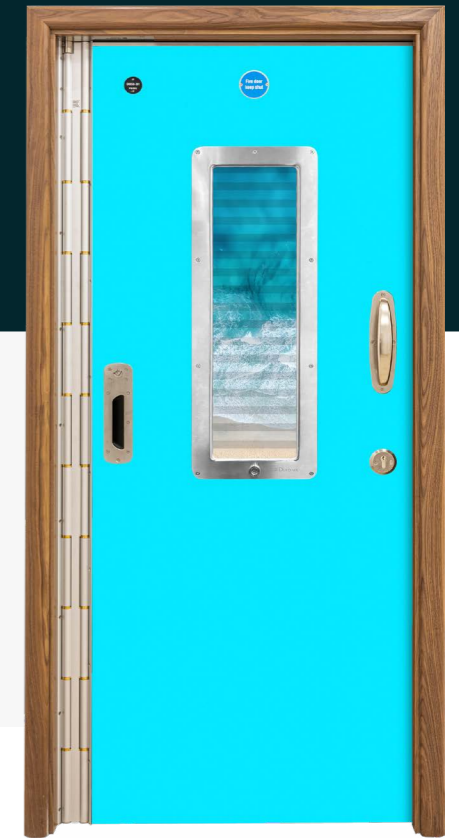

Installation Instructions

- Place the doorset in the opening and pack using suitable material to ensure the gaps are equal all round.
- Drill and fix the hanging jamb making sure it is free from bow and twist.
- Drill and fix the closing leg making sure to keep it perfectly straight to ensure the Switch hinge is not being twisted and that the Switch mechanism is smooth and operating as required.
- On doorsets wider than 900mm it is advisable to fix in the centre of the head to provide extra support and to maintain the correct gap.
- Test Switch door action both ways to 90° to ensure door clears flooring whilst maintaining fire door gap when in closed position.
- Fix frame, firestopping and architraves as detailed in guidance on 'fixings', page 5.
- Fit all intumescents as provided. See page 9 for further details.
- Once the frame securing fixings are fully tightened, the Switch door action must be tested again to 90° in both directions. The SwitchLock mechanism must also be tested for smooth and correct operation.
- Where applied with a Sentry edge alarm, doors should not be wedged open as this risks the alarm's integrity and will invalidate the warranty.
- Ensure door stop is fitted. The door stop must stop the door leaf at 90° max.



For further assistance with installation, please call +44 (0)20 3890 5887 or email us at: install@kingswaygroup.co.uk



The Door Top Monitor Alarmed Door System alerts staff when a life-threatening ligature attempt takes place at the door's top edge.

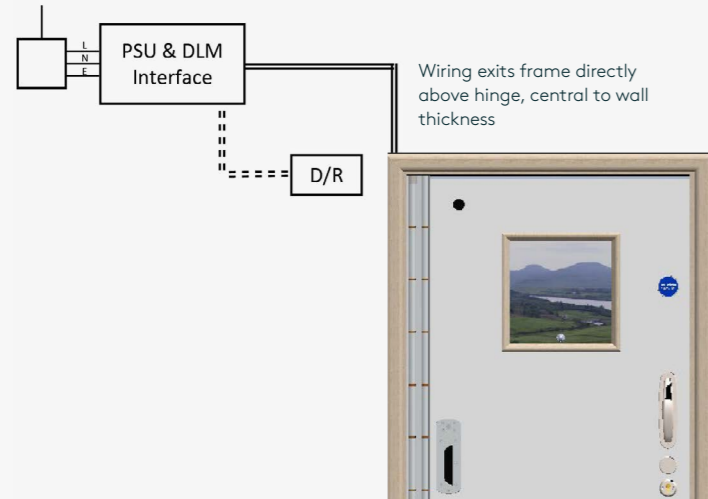

Installation Instructions

- 1 Install the doorset as per guidance in preceding pages relevant to door type.
- 2 Pull alarm cables through containment to specified location for interface connection.
- 3 Site interface unit in specified location.
- 4 Carry out continuity tests to ensure all cables are in good condition.
- 5 Press down on the front edge of the sensor (nearest latch) and check the yellow LED on the door activates.
- 6 Press down on the rear edge of the sensor (nearest hinge) and check the yellow LED activates.
- 7 On the outside of the door, press down in the middle of the sensor and check the yellow LED activates.
- 8 On the inside of the door, press down in the middle of the sensor and check the yellow LED activates.
- 9 Once satisfied that the door switches are in good working order, press and hold the sensor and time how long it takes the alarm to activate (between 1-7 seconds depending on what has been selected).



For further assistance with installation, please call +44 (0)20 3890 5887 or email us at: install@kingswaygroup.co.uk



Intumescent Details

Intumescent and seals guide:

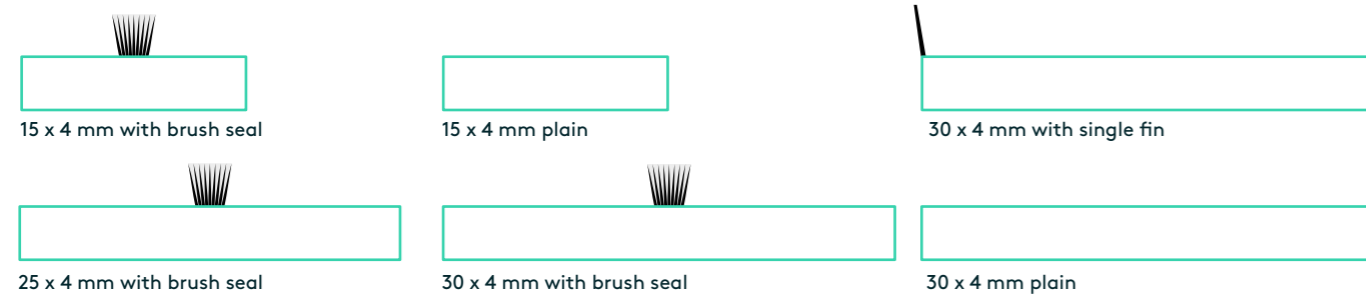

	Door type	Frame	Door	Head closer	DTM	SENTRY	KG21/KG35 & SENTRY
Solo		15 x 4 mm brush in frame grooves (1 strip for FD30 and 2 for FD60)	N/A	N/A	30 x 4 with edge fins to head, 15 x 4 with brush on the frame leg, only suitable for FD30	N/A	30 x 4 with edge fins to head, 15 x 4 with brush on the frame leg, only suitable for FD30
Swing	Single Leaf	15 x 4 mm brush in frame grooves	N/A	15 x 4 plain in the frame head and 30 x 4mm brush in the door head	30 x 4 with edge fins to head 15 x 4 with brush on the frame leg	Frame leg changes to 30 x 4 with edge fin	30 x 4 with edge fins to head 15 x 4 with brush on the frame leg
	Leaf & Half	15 x 4 mm brush in frame grooves	1 no. 10 x 4mm brush plus 1 no. 10 x 4mm flat on vertical edge of half leaf	15 x 4 plain in the frame head and 30 x 4mm brush in the door head	30 x 4 with edge fins to head and 1 no. 10 x 4mm brush plus 1 no. 10 x 4mm flat on vertical edge of half leaf	N/A	30 x 4 with edge fins
Switch		15 x 4 mm brush in frame grooves 15 x 4 plain intumescent 80mm long directly above switch hinge	N/A	15 x 4 plain in the frame head and 30 x 4mm brush in the door head	30 x 4 with edge fins to head, 15 x 4 with brush on the frame leg	Frame leg changes to 30 x 4 with edge fin	30 x 4 with edge fins to head 15 x 4 with brush on the frame leg
Stow		15 x 4 mm brush in frame grooves	N/A	N/A	30 x 4 with edge fins to head, 15 x 4 with brush on the frame leg	N/A	N/A
Stable	Flush Meeting Edge	15 x 4mm brush in frame grooves	Central meeting edge 30 x 4 brush in bottom of top leaf and 15 x 4 plain in top of bottom leaf	N/A	30 x 4 with edge fins to head 15 x 4 with brush on the frame leg	N/A	N/A
	Rebated Meeting Edge	15 x 4mm brush in frame grooves	Central meeting edge 25 x 4 brush in bottom of top leaf and 15 x 4 plain in top of bottom leaf	15 x 4 plain in the frame head and 30 x 4mm brush in the door head	30 x 4 with edge fins to head 15 x 4 with brush on the frame leg	N/A	30 x 4 with edge fins to head 15 x 4 with brush on the frame leg
Shower		N/A	N/A	N/A	N/A	N/A	N/A
Service		15 x 4 mm brush in frame grooves (1 strip for FD30 and 2 for FD60)	N/A	N/A	N/A	N/A	N/A

Technical Components

	Voltage	Consumption	Cable colour
Door alarm trigger cable	-	-	Yellow
			Blue
Door alarm monitor LED	12 - 24v	20mA	Red
			Black
			Green
KOSMOS Vison Panel Monitor	-	-	White
			Brown
KOSMOS Door Position Sensor	-	-	Orange
			Blue
KG240 Electric Strike	12 - 24v	220mA at 12v, 110mA at 24v	Blue
KG75 Electric Handle	12 - 24v	Volt free contact	Blue
KG222 3 Point Mag Lock	12 - 24v	1500mA at 12v (500mA per lock) 750mA at 24v (250mA per lock)	Black
KG37 Free Swing Closer	24v	500mA	Grey
KG38 Electro Hold Open Closer	24v	900mA	Grey
Switchable Glass	48v	120mA per m2	Orange

ATI-2

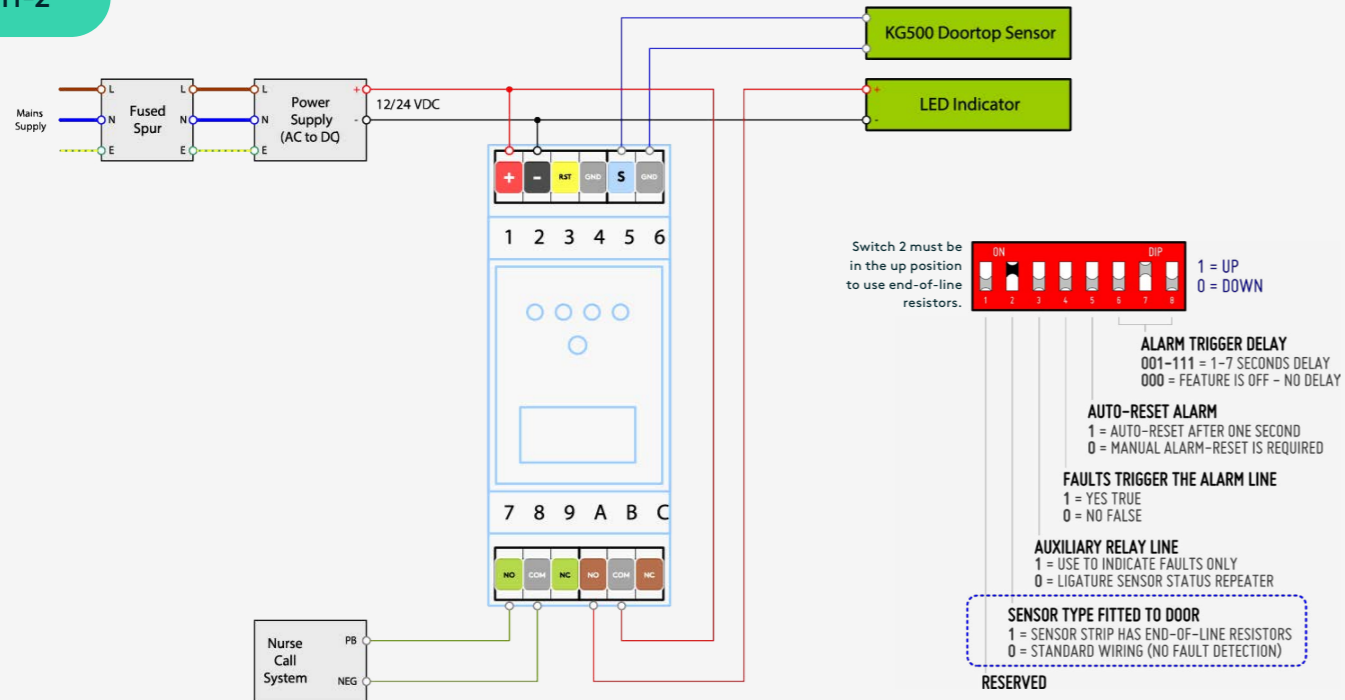

KG240 Electric Strike

Electric Strike (KG240) to be supplied factory fitted to Kingsway Door Set c/w standard (200mm) cable length. Final connections to door access controller by specialist.

- The two-core power wiring will exit the door frame on the closing jamb side at approx. 1020mm from the FFL.

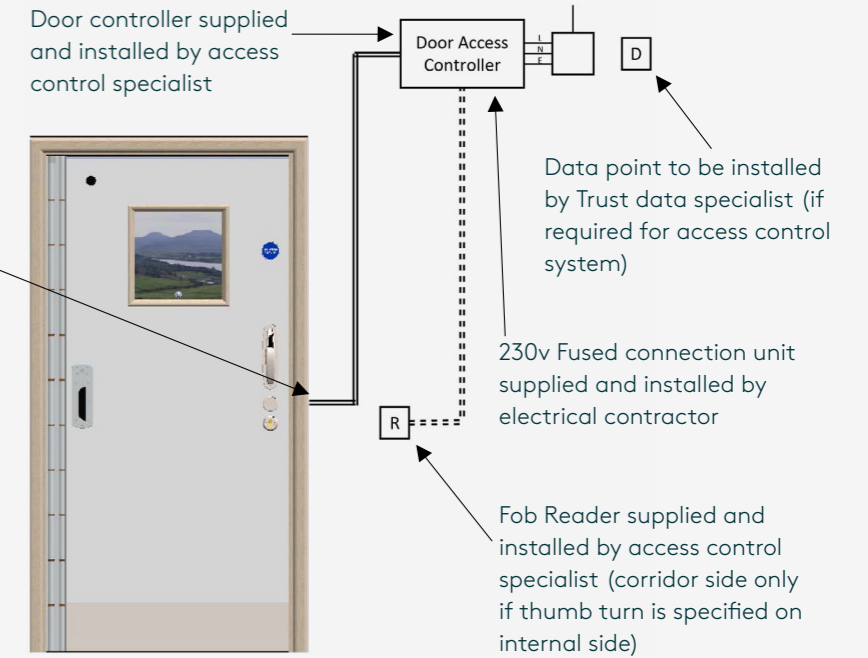

ATI-3

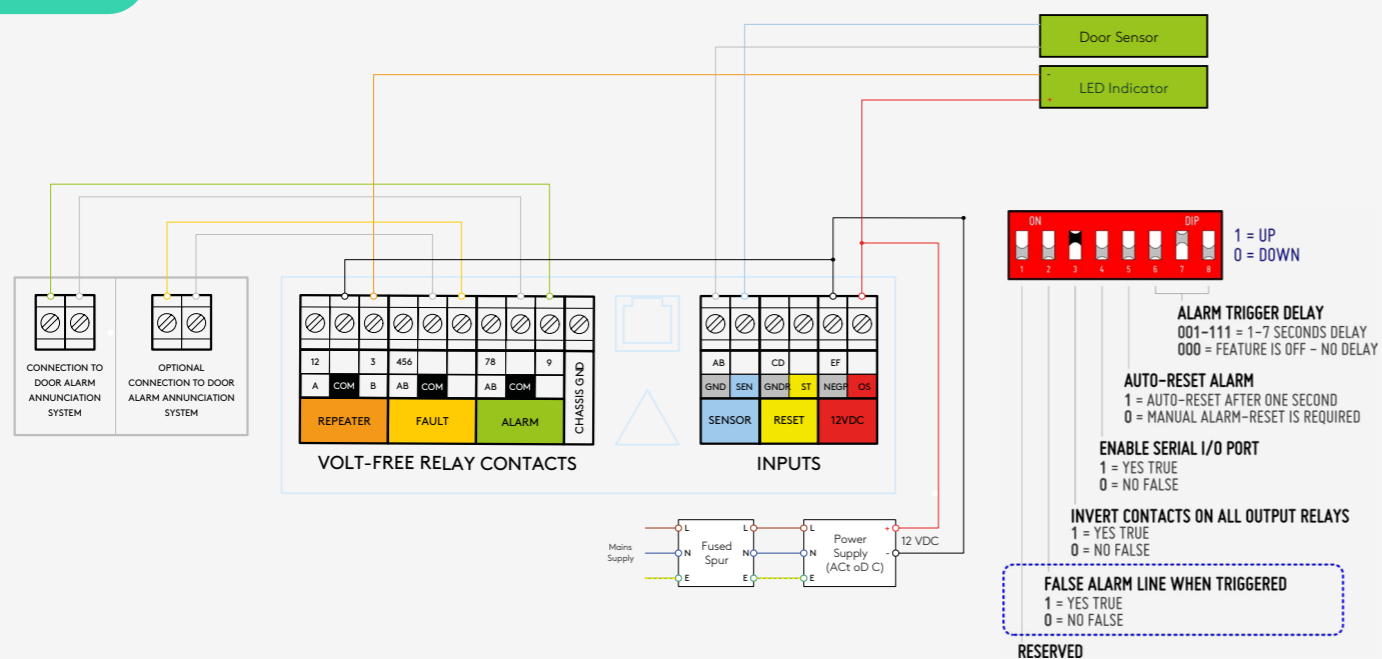

KG222 Triple Mag Lock

Kingsway High Secure Mag Housing (KG222) to be supplied factory fitted to Kingsway Door Set c/w 10m excess cabling.

- Cable will exit the frame at the head of the frame on the closing jamb side.

These can be jumper switched to be either 12 or 24V. Connections according to the diagrams will need to be made on site according to the client specifications.

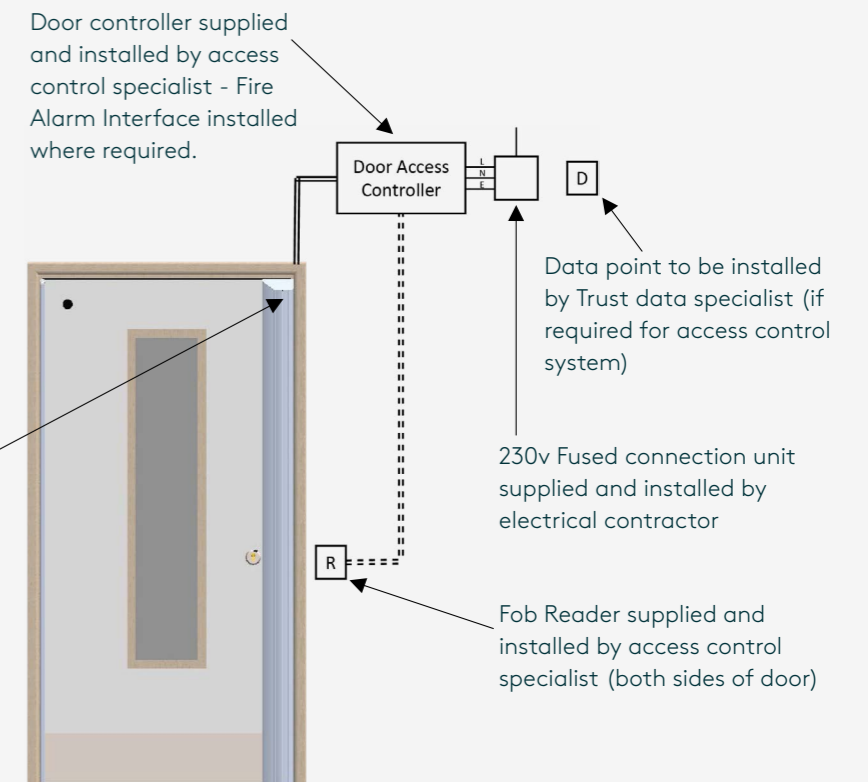

Wiring Components

SENTRY Door Ligature Monitor (DLM)

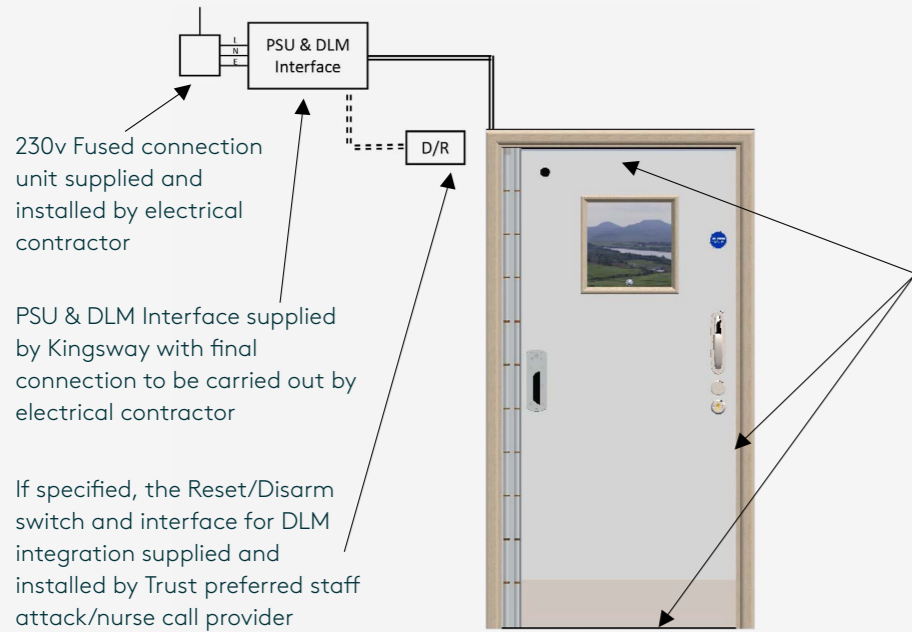

SENTRY Door Ligature Monitor (DLM):

10m cabling will be provided with each door set incorporating our DLM (with factory connection already made).

- The wiring for this element will exit the frame head directly above the hinge central to the wall thickness.
- This will be on the hinge side of any single doors
- This will be on the main leaf hinge side of any leaf & half doors

Please Note: As standard a 12V Power Supply Unit (PSU) will be supplied for each door set. The Kingsway Door Ligature Monitor Interface Unit will be supplied inside each power supply unit (mounted on a DIN rail).

KG37 Electric Transom Closer

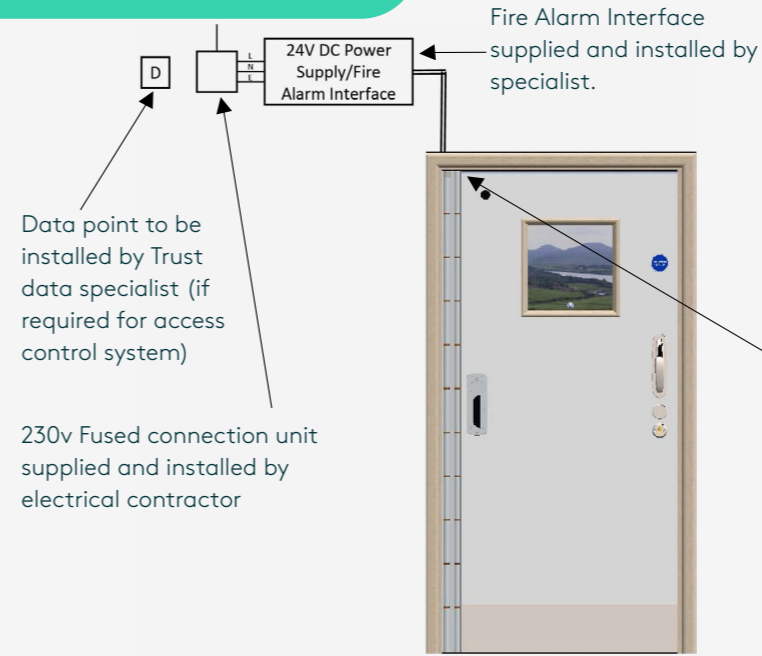

Kingsway Free Swing Closer (KG37) supplied factory fitted to Kingsway Door Set c/w 3m excess cabling.

This device (DORMA BTS 80 FLB-EN5) will be accessible from the door frame head approx. 50mm in from the hanging jamb edge and central to the wall thickness.

- This will be on the main leaf hinge side of any leaf & half doors
- This will be on the hinge side of any single doors

Connection to power/fire alarm interface is required. Operating voltage is 24VDC \pm 15%, residual ripple max. 30%

Note; this closer doesn't 'hold' the door open, it would just deactivate the closer meaning the door can rest in any position until the fire alarm is activated, or power is cut.

KG500 Door Top Monitor (DTM)

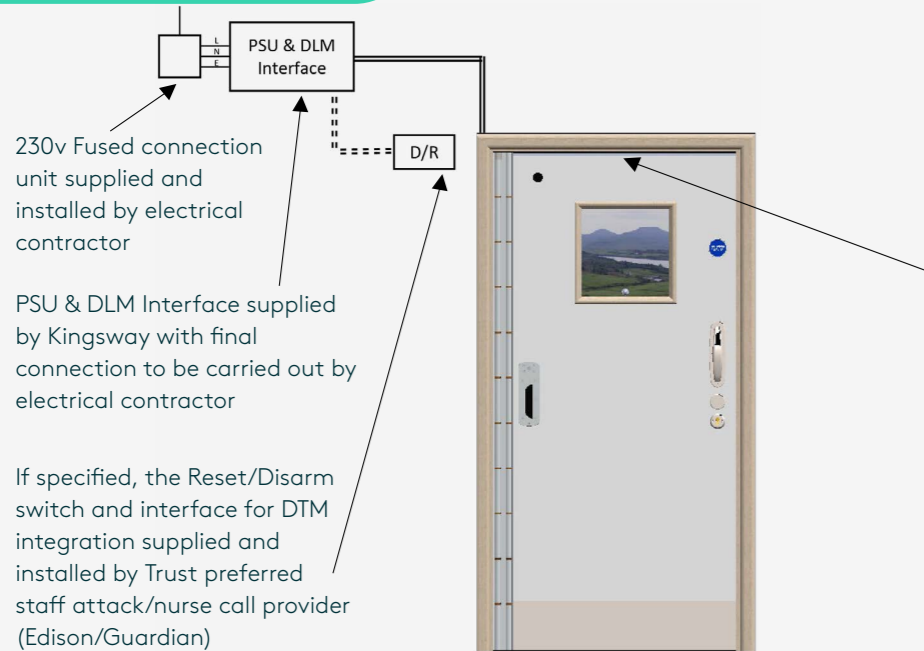

KG500 Door Top Monitor (DTM):

10m cabling will be provided with each door set incorporating our DTM (with factory connection already made).

- The wiring for this element will exit the frame head directly above the hinge central to the wall thickness.
- This will be on the hinge side of any single doors
- This will be on the main leaf hinge side of any leaf & half doors

Please Note: As standard a 12V Power Supply Unit (PSU) will be supplied for each door set. The Kingsway Door Ligature Monitor Interface Unit will be supplied inside each power supply unit (mounted on a DIN rail).

KG38 Electric Transom Closer

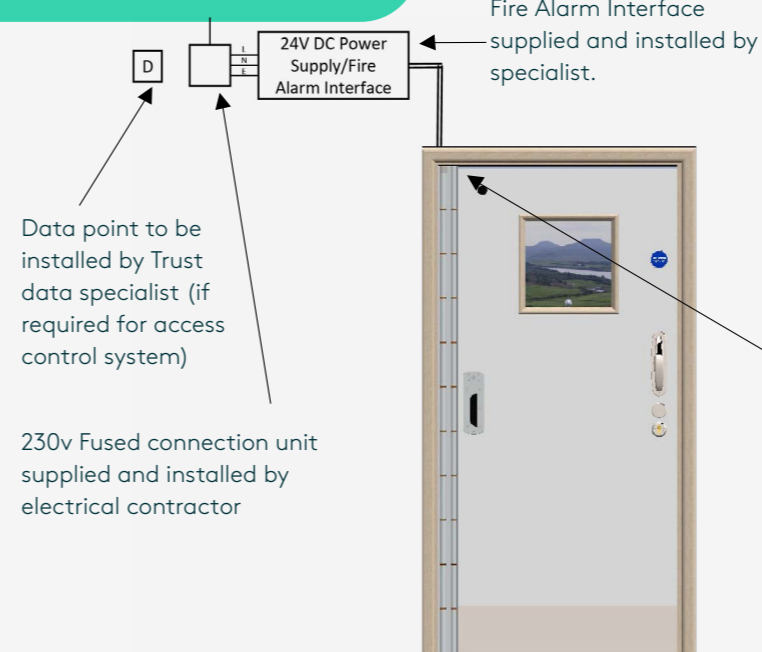

Kingsway Hold Open Closer (KG38) supplied factory fitted to Kingsway Door Set c/w 3m excess cabling.

This device (DORMA BTS 80 EMB-EN5) will be accessible from the door frame head approx. 50mm in from the hanging jamb edge and central to the wall thickness.

- This will be on the main leaf hinge side of any leaf & half doors
- This will be on the hinge side of any single doors

Connection to power/fire alarm interface is required. Operating voltage is 24VDC \pm 15%, residual ripple max. 30%

Note; this closer holds the door open at 90° until the fire alarm is activated, or power is cut.

Installation Checklist

Inspection & Maintenance

▶	Door Leaf	Ensure gaps from leaf to frame are within specified tolerance
		Check the free movement of the door in both directions where applicable to ensure it doesn't catch on the floor
		Free from damage
		Fitting plumb, level and square in the frame
▶	Door Frame	Consistent gap between the door and frame as specified
		Free from damage
		Correct number, type, size and location of wall fixings
		All fixings correctly plugged and finished
▶	Fire & Smoke Seals	Correct packing materials used between the wall and frame
		Compatible with the doorset based on the instructions (See page 4)
		Fitted flush in the grooves and without gaps
		Smoke seals fill the gap between the door and frame on all sides
▶	Latch or Lock	Free from damage
		Engages securely within the keep when closed
		Operates without undue friction
▶	Hinges	Free from damage
		Functioning correctly without undue friction
		If the hinge has been taken off at some point check that it has been refitted correctly and all fixings are secure
▶	Anti-Barricade items	Swing Stops can open outwards fully without hinderance or friction
		Switch hinges are operating correctly without friction
		Door opens in both directions without binding on the floor
		Free from damage
▶	Vision Panels	Functioning vision panels operate smoothly
		Frames and glass free from damage
▶	Other hardware	Free from damage and correctly functioning
		Door closers functioning correctly and fully closing the door
		Electrical products correctly wired and functioning
▶	Architrave	Free from damage
		Fitted correctly without gaps
		All fixings either plugged or finished with wax

All doors should be inspected regularly for damage that prevents the door performing in the event of a fire or an emergency situation, such as a barricade scenario. The following has been drawn up as a guide: **Maintenance must be carried out by a BM Trada certified door maintainer if installed by BM Trada door installer.**

Area	Type of check	Frequency
Door Leaf	Free from damage	1 month
	Consistent gap between the door and frame as specified	6 months
Door Frame	Free from damage	6 months
Fire & Smoke Seals	All present and free from damage	3 months
Latch or Lock	Engages securely within the keep when closed	1 month
	Operates without undue friction	1 month
	Free from damage and all fixings are present and secure	1 month
Hinges	Functioning correctly without undue friction	weekly
	Free from damage and all fixings are present and secure	weekly
Anti-Barricade items	Swing Stops are functioning correctly without friction or damage and all fixings are present and secure	weekly
	Switch hinges are operating correctly without friction or damage and all fixings are present and secure	Weekly
	Door opens in both directions without binding on the floor	Weekly
Vision Panels	Functioning vision panels operate smoothly	Weekly
	Free from damage and all fixings are present and secure	Weekly
Other hardware	Free from damage, functioning correctly and all fixings are present and secure	Weekly
	Door locks and unlocks correctly without hinderance	Weekly
	Door closers are continuing to function correctly and close the door	Weekly
Architrave	Electrical products working correctly	Weekly
	Free from damage	6 months
	Fitted correctly without gaps	6 months

Have a technical issue, or a query? Call +44 (0)20 3890 5887 or email us at: install@kingswaygroup.co.uk

Door Alarm Monitor Fault Codes

ATI Unit LED Guide

LED	Normal condition	Possible causes	Action	Typical values	Power consumption
Green	Permanently lit	If no light check power	Check fuses and battery	Psu 12VDC to 24VDC	200mA @12VDC
Yellow	Regular flashing	If not flashing check power	Check fuses and battery	Psu 12VDC to 24VDC	100mA @ 24VDC
Blue	Should be lit when the alarm is activated	If permanently lit check whether sensors are stuck	Check there are no shorts/faults present on the sensor, remove sensor from interface if the blue light doesn't extinguish change interface	Quiescent 9k7ohms Alarm 2k2 ohms	
			Check dip switch 5 correctly set 1 = Auto reset 0 = Manual reset		
Red	0 = Normal condition				
	1 = Under voltage(low battery)		Use multimeter to make sure the voltage is correct and check battery with battery tester		
	2 = Over voltage		Use multimeter to make sure the voltage is correct		
	3 = Door sensor not connected (EOL resistors only)	Check dip switch 2 is in the correct place 1 = Sensor strip has a EOL resistors 0 = No EOL Resistors (non monitoring)	Check if resistor pack is fitted		
	4 = Connection to door sensor is shorted (EOL resistors only)	Check if cables have been interrupted or shorted	Remove short/repair/replace cables		
		Check if sensor is connected to interface	Make sure they've not been mixed up with remote LED cables		
	5 = Relay contact's lifetime has been exceeded		Replace interface		
	Once finished, check the ligature monitor activates and sets the alarm off correctly				

Have a technical issue, or a query? Call +44 (0)20 3890 5887 or email us at: install@kingswaygroup.co.uk

